



OSM/EE DECISION SHEET

Category	Standard:	Clause	Document no.
OFF, TRON	EN 60950-1:2006, A1, A2 EN 60065:2014 EN 62368-1:2014	1.5.1 & 0.3 (60950-1) 3.3 & 14.6.5 (60065) 4.1.5 & G3.5.1 (62368-1)	OSM/EE 17.2A
Subject		Key words	Meeting
Resistor on the primary side as “protective device” (fusible resistors)		Fusible resistor – Primary circuit – Protective device	Zurich 2017 Ljubljana 2019
Question			
In which conditions can a resistor be used in the primary circuit, as a “protective device”			
Decision			
<p>We may accept fusible resistors on the primary side to be used as “protective devices”, provided that they comply with all the following conditions:</p> <p>a) They shall be used within their specification (see explanatory notes).</p> <p>b) They shall operate satisfactorily when the appliance is tested.</p> <p>The short circuit current shall be determined under worst case fault condition, using a supply source with prospective short circuit current of at least 1 500A by performing the test three times, each time with a new resistor.</p> <ul style="list-style-type: none"> - If the measured short circuit current during any of the tests is > 35A, fusible resistor(s) shall not be used. - If the short circuit current is ≤ 35A, satisfactory operation of the fusible resistor shall be checked. Tests and measurements shall demonstrate that during worst case fault condition the resistor operates within its specification and there is no risk of overload (overheating or explosion; refer to attached graphics). <p>Furthermore the following criteria as specified in EN 60127-8 clause 9.3.2 shall be considered:</p> <p>It shall operate without any of the following phenomena:</p> <ul style="list-style-type: none"> - permanent arcing; - ignition; - bursting of the fuse resistor; - illegibility of marking after test (see item f). <p>The following phenomena are neglected:</p> <ul style="list-style-type: none"> - black spots or other marks on the terminations or the body of the fuse resistor - arcing times of less than 1ms. <p>c) Resistors are not accepted in operator access area.</p>			

d) Resistors is to be listed as critical component in the test report.

e) Resistors cannot be marked as interchangeable. For alternate type resistors satisfactory operation shall be demonstrated when tested in the appliance.

f) Identification using part number or the like is to be located adjacent to the resistor such as for fuses.

This applies only to service replaceable parts.

g) Test results shall be documented in the test report and a data sheet provided showing all the relevant data for the resistor.

Explanatory notes

This decision replaces OSM-EE decision no. 99/1 which was according LVD AdCo's opinion not complete as proof of evidence for compliance of a fusing resistor used as protective device.

- LVD AdCo supports the Decision. Ref. e-mail from the Chairman of LVD-ADCO Sept. 05, 2017.
- CENELEC TC 108X confirmed the Decision in their Plenary meeting of Dec. 06 & 07, 2017.

Refer to following documents :

- CLC/TC 108X/SEC0305/DC (added below)
- TC 108 Interpretation Panel – Q.02 (added below)
- EN 60127-8:2018

In Ljubjana 2019, OSM-EE decision 17/2 was modified with following changes:

- added reference to EN 60127-8,
- modified number of repetitions from 10 to 3 to align with requirements of the standard EN 62368-1:2014, clause G.3.5.2.

EN IEC 60127-8:2018 (E)

European foreword

The text of document 32C/542/FDIS, future edition 1 of IEC 60127-8, prepared by SC 32C "Miniature fuses" of IEC/TC 32 "Fuses" was submitted to the IEC-CENELEC parallel vote and approved by CENELEC as EN IEC 60127-8:2018.

The following dates are fixed:

- latest date by which the document has to be implemented at national level by publication of an identical national standard or by endorsement (dop) 2019-04-30
- latest date by which the national standards conflicting with the document have to be withdrawn (dow) 2021-07-31

Attention is drawn to the possibility that some of the elements of this document may be the subject of patent rights. CENELEC shall not be held responsible for identifying any or all such patent rights.

Endorsement notice

The text of the International Standard IEC 60127-8:2018 was approved by CENELEC as a European Standard without any modification.

EN 60127-8:2018 clause 9.3.2

The fuse resistor with particular overcurrent protection shall operate satisfactorily without any of the following phenomena:

- permanent arcing;
- ignition;
- bursting of the fuse resistor with particular overcurrent protection;
- illegibility of marking after test.

The following phenomena are neglected:

- black spots or other marks on the terminations or the body of the fuse resistor with particular overcurrent protection;
- arcing times of less than 1 ms.

IEC PAS 60127-8:2014 clause 9.3.2

9.3.2 Criteria for satisfactory performance

The requirements of IEC 60127-1:2006, 9.3.2, are replaced as follows:

The fuse resistor with particular overcurrent protection shall operate satisfactorily without the following phenomena:

- permanent arcing;
- ignition;
- bursting of the fuse resistor with particular overcurrent protection;
- illegibility of marking after test.

The following phenomena are neglected:

- black spots or other marks on the terminations or the body of the fuse resistor with particular overcurrent protection;
- arcing times of less than 1 ms.

EUROPEAN COMMITTEE FOR ELECTROTECHNICAL STANDARDIZATION (CENELEC)**TECHNICAL COMMITTEE No. 108X: SAFETY OF ELECTRONIC EQUIPMENT WITHIN THE FIELDS OF AUDIO/VIDEO, INFORMATION TECHNOLOGY AND COMMUNICATION TECHNOLOGY**

Proposal for EN 60950-1 to deal with the risk of fusible resistors.

Introduction

In the CLC/TC 108X meeting on 3 and 4 December 2014 we discussed the issue brought forward by LVD Adco related to safety issues when using fusible resistors as a protective device. The meeting decided to draft a common modification to EN 60950-1 to clarify the issue. The document is providing background information and proposes text to be added in EN 60950-1.

Background and problem description

Fusible resistors have been used extensively over the last couple of decades. They are reliable components, similar as fuses, assuming they are used within their specifications. Recently however, they have been used in different products where they might be used outside of their specifications. This might result in either high temperatures and fire or in explosion. As a result, these fusible resistors should be used within their specifications to avoid these problems.

Coverage by TC 108 related standards

This requirement is at least partly covered in IEC/EN 60065 and IEC/EN 62368-1. Unfortunately, this is not sufficiently covered in IEC/EN 60950-1.

IEC 60065:**3.3 Constructions and components not specifically covered**

Where the equipment involves technologies, components and materials or methods of construction not specifically covered in this standard, the equipment shall provide safety measures not less than that generally afforded by this standard and the principles of safety contained herein.

14.6.5 Protective devices not mentioned in Fehler! Verweisquelle konnte nicht gefunden werden., Fehler! Verweisquelle konnte nicht gefunden werden. or Fehler! Verweisquelle konnte nicht gefunden werden.

Such protective devices, for example fusing resistors, fuses not standardized in IEC 60127 or miniature circuit breakers, shall have adequate breaking capacity.

IEC 62368-1:**4.1.5 Constructions and components not specifically covered**

Where the equipment involves technologies, components and materials or methods of construction not specifically covered in this standard, the equipment shall provide **safeguards** not less than that generally afforded by this standard and the principles of safety contained herein.

G.3.5 Safeguard components not mentioned in G.3.1 to G.3.4**G.3.5.1 Requirements**

Such protective devices (for example, fusing resistors, fuse-links not standardized in IEC 60127 series or miniature circuit breakers) shall have adequate rating including breaking capacity.

Technical background related to the use of fusible resistors

Every fusible resistor has a datasheet with a figure such as the example given below, indicating the behaviour of the fusible resistor during overload:

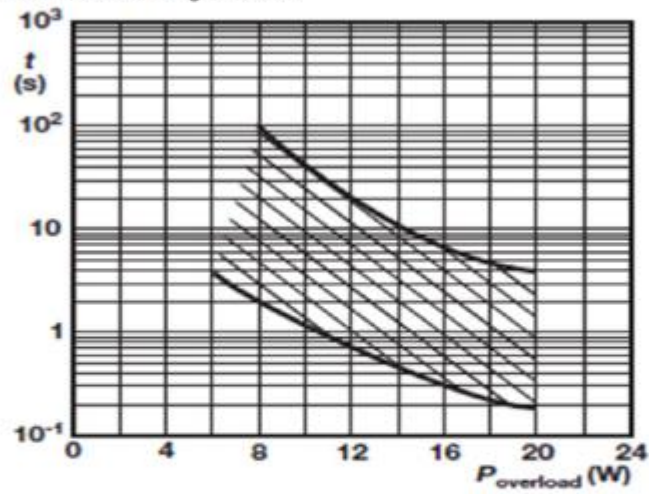

In the component datasheet, it can also be found how much energy the fusible resistor is able to handle during normal load, often called rated dissipation, as indicated in the example below:

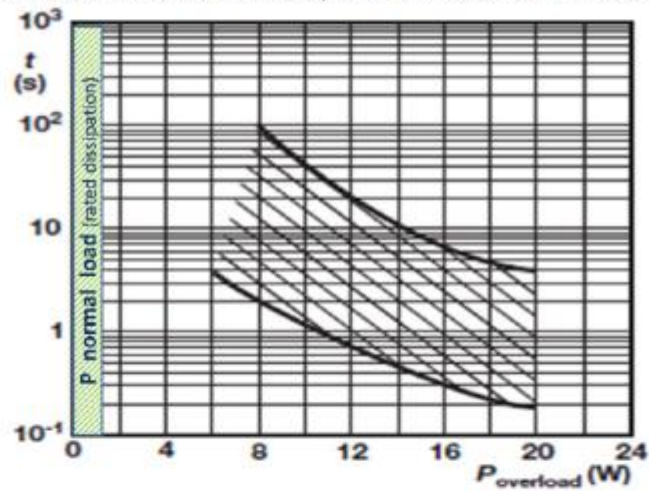

If the fusible resistor is used above the normal load, but below the specified overload region, there is a risk of overheating. This is due to the fact that the resistor is overloaded, but does not have enough power available to interrupt in a timely manner. The resistor will heat up, but there is no guarantee that it will interrupt. Due to the fact that the resistor needs some time to heat up, the risk zone does not start from time zero. At least several seconds will be needed to reach an unsafe temperature. This area is represented in the example below:

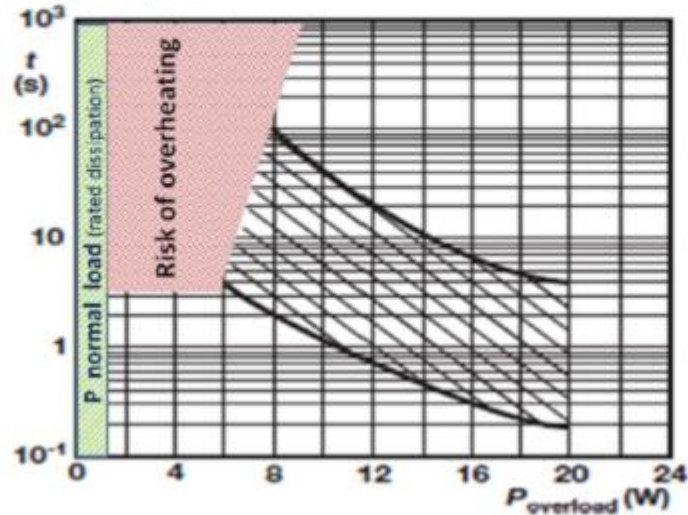

If the fusible resistor is used above the maximum specified overload, there is a risk of explosion. This is due to the fact that there is much more energy available than what the resistor was designed for. The resistor might not be able to dissipate enough energy in a timely manner. This area is represented in the example below:

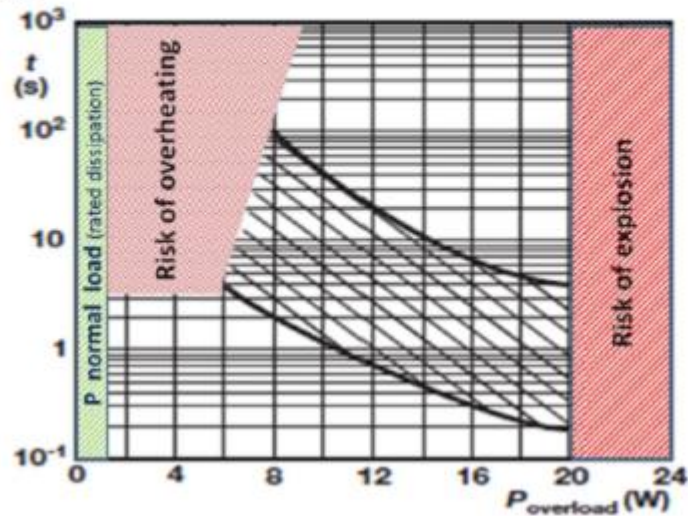



TC108 Standards Interpretation Panel QUESTION

October 28, 2015

IEC 60950-1, Ed. 2, Am 2

Information technology equipment – Safety – Part 1: General requirements

2.7.3 Short-circuit backup protection

Background:

Fusible resistors have been used extensively over the last couple of decades. They are reliable components, similar to fuses, assuming they are used within their specifications. Recently however they have been used in different products where they might be used outside of their specifications. This might result in high temperatures, fire or explosion. As a result, these fusible resistors should be used within their specifications to avoid these problems.

The EU LVD Administrative Co-operation Working Group (LVD ADCO) has expressed concern related to safety issues when fusible resistors are used as a protective device in safety standards maintained by IEC TC108. Upon further study,

- LVD ADCO and CLC/TC108X believe IEC 60065 covers the concern by inclusion in the standard of sub-clauses 3.3, Constructions not specifically covered, and 14.6.5, Protective devices not mentioned in 14.6.2, 14.6.3 or 14.6.4.

- LVD ADCO and CLC/TC108X believe IEC 602368-1 covers the concern by inclusion in the standard of sub-clauses 4.1.5, Constructions not specifically covered, and G.3.5/G.3.5.1, Safeguard components not mentioned in G.3.1 to G.3.4 - Requirements.

However, it remained unresolved whether IEC 60950-1 similarly covered the concern with such fusible resistors.

This Interpretation clarifies that IEC 60950-1 adequately covers safety of fusible resistor used in ITE until the full transition to IEC 62368-1.

Question to the Panel:

Does the Interpretation Panel agree that the published IEC 60950-1 covers safety of fusible resistors used in ITE by nature of the following requirements?

(a) Subclause 1.3.4, Constructions not specifically covered, which requires, “Where the equipment involves technologies and materials or methods of construction not specifically covered in this standard, the equipment shall provide a level of safety not less than that generally afforded by this standard and the principles of safety contained herein.”

(b) Subclause 2.7.3 Short-circuit backup protection, which states, “Unless appropriate short-circuit backup protection is provided, protective devices shall have adequate breaking (rupturing) capacity to interrupt the maximum fault current (including short circuit current) which can flow,” and its compliance statement, “Compliance is checked by inspection and by the tests of 5.3.”

Specifically for Europe, the following is noted in an in some countries note in 2.7/2.7.1, Overcurrent and earth fault protection in primary circuits Basic requirements:

NOTE In the member countries of CENELEC and in China, the protective devices necessary to comply with the requirements of 5.3 must, with certain exceptions, be included as part of the equipment.

(c) Furthermore, subclauses, 5.3.9 Compliance criteria for abnormal operating and fault conditions, and 5.3.9.1 During the tests, states,

During the tests of 5.3.4 c), 5.3.5, 5.3.7, 5.3.8 and Clause C.1:

- if a fire occurs, it shall not propagate beyond the equipment; and
- the equipment shall not emit molten metal; and
- ENCLOSURES shall not deform in such a way as to cause non-compliance with 2.1.1, 2.6.1, 2.10.3 (or Annex G) and 4.4.1.

(d) Additionally, a requirement in 4.7.3.2 is included that requires, for plastic materials of fire enclosures located less than 13 mm through air from non-arcing parts which under any condition of normal or abnormal operation could attain a temperature sufficient to ignite the material, an average time to ignition of the samples shall not be less than 15 s per IEC TS 60695-2-20, Fire hazard testing - Part 2-20: Glowing/hot wire based test methods - Hot-wire coil ignitability - Apparatus, test method and guidance. Although IEC TS 60695-2-20 has been withdrawn by IEC TC89 due to concerns with repeatability and reproducibility, by normative reference in IEC 60950-1, it remains a requirement for applicable constructions to comply with IEC 60950-1.

Opinion of the Panel:

The Standards Interpretation Panel agrees that IEC 60950-1 adequately covers the safe use of fusible resistors in ITE, based on the rationale provided in the Question to the Panel.

Action:

None. The existing requirements for fusible resistors used in ITE will be replaced by IEC 62368-1 as part of the transition to IEC 62368-1.



OSM/EE DECISION SHEET

Category	Standard:	Clause	Document no.
OFF	EN 62368-1:2014	Annex E	OSM-EE 18/2
Subject		Key words	Meeting
Determination of audio amplifier normal operating condition		Audio amplifier Normal operating condition	London 2018
Question			
<p>What is the correct way to determine normal operating condition for an active 3-way (woofer, mid, tweeter) loudspeaker with separate amplifier for each driver?</p> <ol style="list-style-type: none"> 1. Input 1kHz signal, turn volume up until clipping and record the maximum unclipped power of the clipping amplifier. Input pink noise signal, turn volume up until amplifier that clipped is delivering 1/8 of its maximum unclipped power. 2. Input 1kHz signal, turn volume up until clipping and record the maximum unclipped power of the clipping amplifier. Input pink noise signal, turn volume up until any of the three amplifiers delivers 1/8 of the maximum unclipped power of the amplifier that clipped the 1kHz signal. 3. Determine the peak response frequency for all three amplifiers. Input the peak response frequency for each amplifier one at the time, turn volume up until clipping and record the maximum unclipped power of the amplifier. Input pink noise signal, turn volume up until one of the amplifiers is delivering 1/8 of the maximum unclipped power recorded at the peak response frequency. 			
Decision			
<p>OSM is of the opinion that option 3. is the correct method. Confirmed by TC108 at Busan, Korea, Oct 2018</p>			
Explanatory notes			
<ol style="list-style-type: none"> 1. Is not correct because clipping and 1/8 power is only determined for one of three amplifiers so the power of the other two is unknown. This might, for some constructions, result in clipping of the output for the unmeasured amplifiers during normal operating conditions. 2. Is not correct because clipping is only determined for one of three amplifiers and then 1/8 of that level is applied to all amplifiers. For some constructions this will result in very low power output levels for normal operating conditions. 3. According to E.1: The peak response frequency shall be used where an amplifier is not intended for operation at 1kHz For equipment containing multi-channel amplifiers, where some channels cannot be operated independently, those channels shall be operated using the output power level that corresponds, by design, to 1/8 of the non-clipped output power of the adjustable amplifier channel(s). 			



OSM/EE DECISION SHEET

Category	Standard:	Clause	Document no.
OFF	EN 62368-1:2014	Annex T.6	OSM-EE 18/3
Subject	Key words		Meeting
Loose enclosure parts inside equipment after impact test	Enclosure, impact test		London 2018
Question			
<p>If a part of the enclosure is loosen/detached as a result of the impact test (T.6) and ends up within the equipment. How should it be handled with regard to creepage and clearance?</p> <p>Should it only be considered to affect creepage and clearance where it lands or should it be moved around (using 10N test of T.2 or similar method)?</p> <p>Is it any different for conductive parts (that might bridge insulation) and none conductive parts (that might create shorter creepage distances than the original construction)?</p>			
Decision			
<p>If conductive loose parts occur after the impact test, it must be checked that it cannot result in any hazardous situation (by placing the loose part in the worst case possible position within the equipment)</p> <p>Confirmed by TC108 at Busan, Korea, Oct 2018</p>			
Explanatory notes			



OSM/EE DECISION SHEET

Category	Standard:	Clause	Document no.
OFF	EN 62368-1:2014	5.7.4	OSM-EE 18/5
Subject	Key words		Meeting
Touch current measurement	Touch current, earthed part, switches		London 2018
Question			
<p>Standard EN 62368-1 in clause 5.7.4 requires that at least one earthed accessible part shall be subjected to touch current measurement and refers to IEC/EN 60990:1999 for conditions of measurements.</p> <p>a) Is it required to open switch e while conducting relevant faults 6.2.2.2 to 6.2.2.8 (parallel operation of switch e open with other switches)?</p> <p>b) if a) is yes, doesn't this means double fault (fault in earthing and in addition fault in network)?</p>			
Decision			
<p>a) YES</p> <p>b) NO, OSM is of the opinion that opening switch "e" is a loss of a safeguard. For measurements on class I equipment switch "e" must be open together with any combination of the other switches in the figure one at the time. Except for the line conductor switch "l" which simulates a line/neutral fault in the installation. If however the equipment contains a single pole mains switch, it shall additionally be tested with the mains switch in the equipment open and closed</p> <p>Confirmed by TC108 at Busan, Korea, Oct 2018</p>			
Explanatory notes			
<p>Switch e simulates opening of protective earthing conductor in non-reliable earthed product.</p> <p>Switch n simulates opening of one pole switch in neutral conductor</p> <p>Switch p simulates polarity connection of the product.</p> <p>Switch l simulates line fault for products connected L to L or 3-phase products</p> <p>Switch g simulates fault in supply system – earthing of one phase in isolated mains system</p> <p>Combination of switch e open together with switch g is not considered as a double fault. Any measurement with switch e closed has no sense.</p> <p>Example of required measurements on product connected L to L of single star IT system (Fig 10 of EN 60990)</p>			

OSM/EE DECISION SHEET

Category	Standard:	Clause	Document no.
TRON	EN 60065:2014	14.6.3.3	OSM-EE 18/6
Subject		Key words	Meeting
Fuses in parallel		Fuse	London 2018

Question

Clause 14.6.3.3 of IEC 60065 appears to not allow fuses to be in parallel with each other. (Although the text is not 100% clear because “a fuse” is stated rather than “fuses”):-

- 94 - IEC 60065:2014 © IEC 2014

The marking requirements apply also if the fuse has a rated current outside the range specified in IEC 60127.

Compliance is checked by inspection.

14.6.3.3 Fuse holders, so designed that a fuse can be connected in parallel in the same circuit, shall not be used.

Compliance is checked by inspection.

The schematic shows the primary circuit of a commercial high power amplifier:-

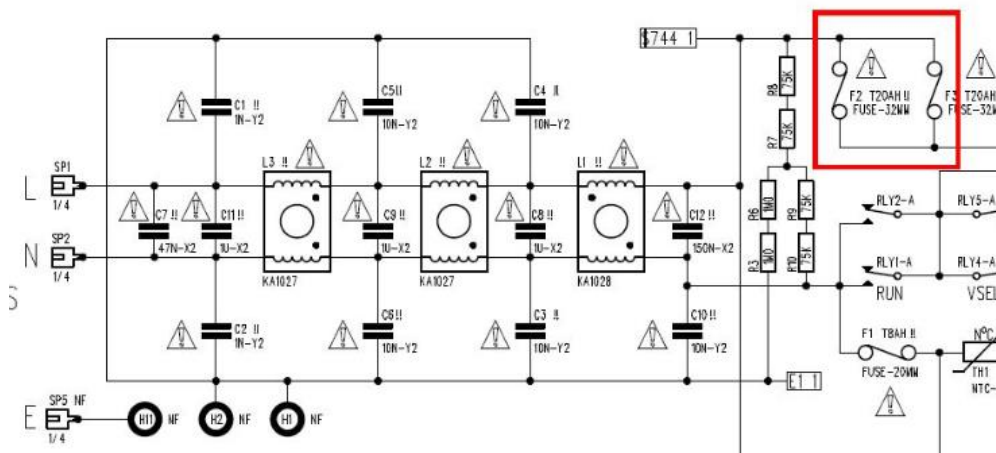

Referring to IEC 62368-1:-

5.6.4.3 Current limiting and overcurrent protective devices

The current limiting device (a PTC device) or the overcurrent protective device (a fuse or a circuit breaker) shall not be connected in parallel with any other component that could fail to a low-resistance state.

This is clearer in that it states that a fuse shall not be connected in parallel with a component that could fail to a low-resistance state. I guess that a fuse in parallel with another fuse is OK for IEC 62368-1 because the 2nd fuse would not generally fail to a lower resistance state than it was to start with.

Can we use this logic to accept the fuses in parallel in an amplifier tested to 60065?

Please see also the Decision 11/3 applicable to EN 60950-1 from Vienna meeting attached

Decision

OSM does not see a technical reason to reject fuses in parallel (not limited to 2).
It should be clarified that the breaking capacity of each of the fuses must be sufficient to cover the total available breaking current of the circuit.

Decision 11/03 refers

Explanatory notes

VIENNA – OSM/EE MEETING FOR ELECTRONIC EQUIPMENT 05 – 06 MAY 2010

-ITEM FORM-

LCIE-France /N°1/2010

Standard: EN 60950-1:2006 + A11:2009 +A1	Sub clause: 2.7.4	Sheet No.: DECISION 11/3 Page 1 of 1
Subject: Fuses in parallel connection, in the input circuit.	Key words: Parallel, Fuses, Input Circuit	Meeting: Vienna, 2010 Agenda item 8.2, Brussels item 5.1.6

Question:

Are two fuses in parallel connection allowed in the input circuit?

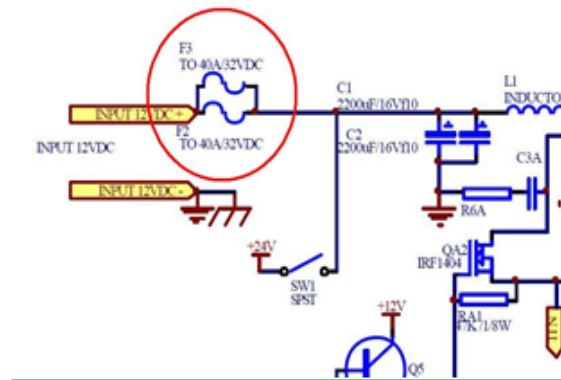

Proposed Decision: No

Decision: OSM EE conclusion: decision only in the minutes

OSM does not see a technical reason to reject fuses in parallel (not limited to 2).

It should be clarified that the breaking capacity of each of the fuses must be sufficient to cover the total available breaking current of the circuit.

Explanatory notes:

Certain low voltage circuits may be rated at 100 A or more (e.g. 3V3/125A). Suitable fuses of such a rating are not available. To protect such circuits, some manufacturers have proposed the use of 2 fuses placed in parallel.

~~Even it's not mentioned clearly in the EN 60950-1, this is part of the basic electrical engineering knowledge and it's therefore not necessary to mention in the standard. In addition,~~

the standard EN 60065:2002, cl. 14.5.2.3 not allows to set the fuses in parallel

14.5.2.3 Fuse holders, so designed that fuse-links can be connected in parallel in the same circuit, shall not be used.

Compliance is checked by inspection

The question will be asked to IEC TC108 MT2. Secretary 2010 action.

IEC TC108 MT2 Seattle 2010-10:

MT2 agreed with the decision of the OSM, but felt that it should be clarified that the breaking capacity of each of the fuses must be sufficient to cover the total available breaking current of the circuit.

OSM/EE DECISION SHEET

Category	Standard:	Clause	Document no.
OFF	EN 62368-1:2014	5.2.2	OSM-EE 19/1
Subject	Key words		Meeting
ES classification	ES1 limits, single pulse, repetitive pulses, output overload		Ljubljana 2019

Question

Result of the abnormal operation (output overload) on switch mode power supply, was protective (hiccup) mode with repetitive pulses on the output. Off time between pulses is >3s (see Fig. 1). Each single pulse last for approximately 700msec. Each single pulse has some ringing. The voltage of single pulse does not exceed 60Vpk.

Can such output be classified as ES1?

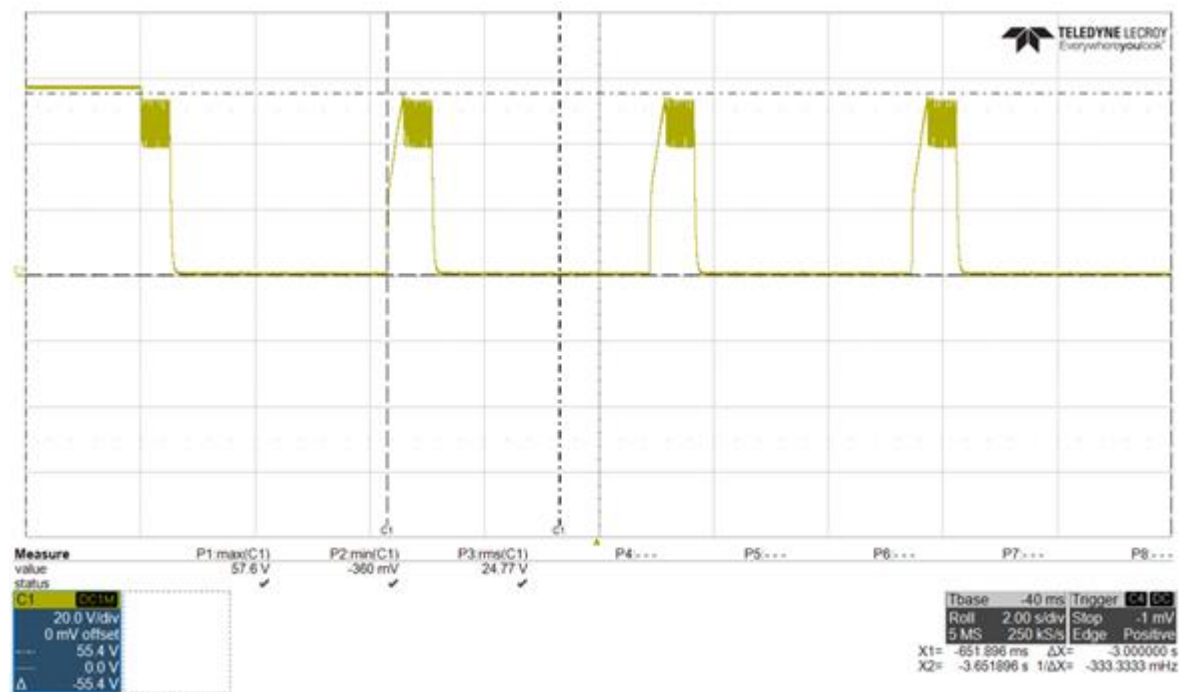

Picture 1 – output hiccup

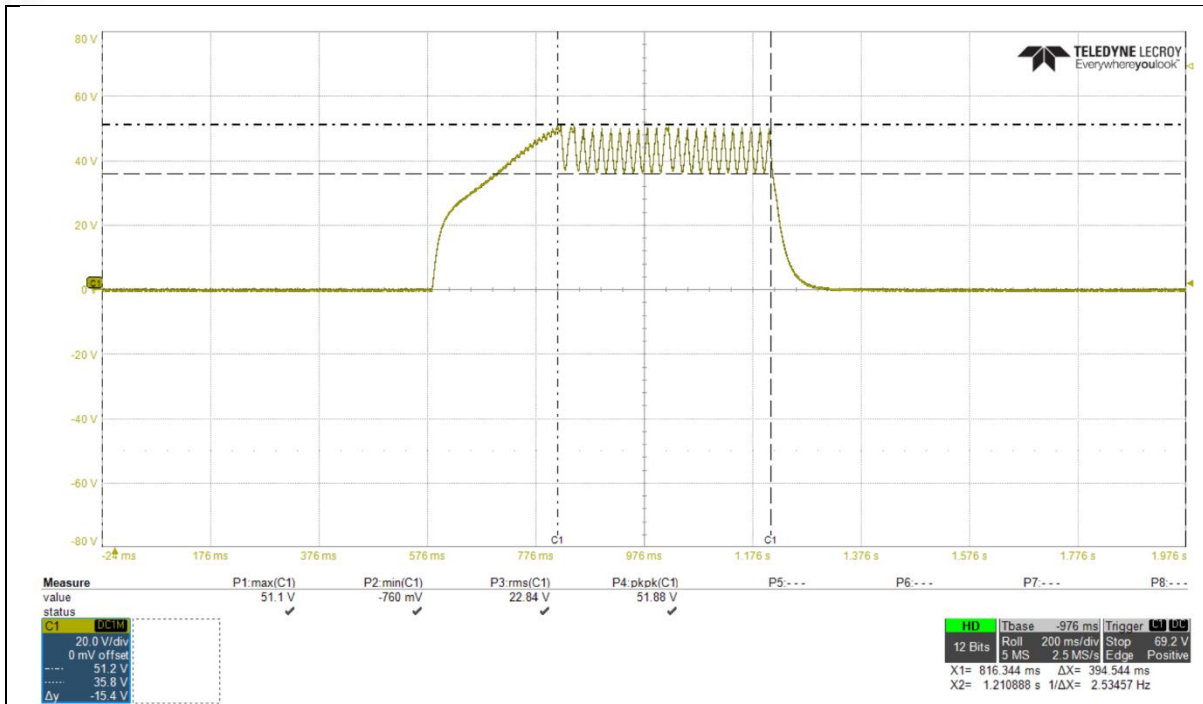

Picture 2 – zoom of single pulse

Decision

Yes. The result of the abnormal test is repetitive pulses, therefore clause 5.2.2.5 applies. Since the off time between the pulses is >3s, the limits for single pulse (5.2.2.4) have to be considered. Since the pulse voltage never exceeds 60Vpk, the output can be classified as ES1

Confirmed by TC108 at Raleigh, 2019

Explanatory notes

The standard does not limit the maximum duration for a single pulse, nor does it consider the shape of a single pulse.



OSM/EE DECISION SHEET

Category	Standard:	Clause	Document no.
OFF, TRON	EN 60065:2014 EN 60950-1:2006+A1+A2 EN 62368-1:2014	5.5 1.7.2 0.5.5.2, F.4	OSM-EE 19/2
Subject		Key words	Meeting
Safety relevant information		Softcopy (electronic form), Hardcopy	Ljubljana 2019
Question			
<p>Is it allowable for such information be provided only in electronic form? More and more manufacturers are nowadays providing the safety, user, operating, and installation instructions on company web site, and the use of the internet is now more integrated in the everyday life.</p> <ol style="list-style-type: none"> 1. Is it acceptable to refer to the company web page for the safety and installation instructions and user manual? 2. If the above is not acceptable, what kind of safety relevant information should be made available in hardcopy? 			
Decision			
<p>Safety relevant documentation to install and operate the equipment has to be provided as a hardcopy. However, the guidelines in LVD ADCO (LVD ADCO 10-11 doc 06 rev2) are also considered acceptable approaches by OSM. Attached to this decision document.</p>			
Explanatory notes			
<p>This decision replaces OSM-EE decisions 13/8 and 99/11 Official Journal of the European Union C272 (Blue Guide) states in §3.1 Unless otherwise specified in specific legislation, instructions and safety information need to be provided (note 100). (note 100) Unless otherwise specified in specific legislation, whilst the safety information needs to be provided on paper, it is not required that all the set of instructions is also provided on paper but they can also be on electronic or other data storage format. However, a paper version should always be available free of charge for the consumers who request it.</p>			

RECOMMENDATIONS
of the **Administrative Co-operation Working Group (LVD ADCO)**



in the framework of Council Directive 2006/95/EEC
on the harmonisation of the laws of Member States relating to
electrical equipment designed for use within certain voltage limits – LVD¹.

- I. If harmonised standards are used and referred to in the EC declaration of conformity, the presumption is that the product complies with essential requirements of the Low Voltage Directive (LVD). If other standards and methods are used, the technical documentation should show evidence that the product fulfils the essential requirements of LVD. It is for the authority to prove non-conformity of the product with the provisions of the LVD before undertaking restrictions. (Helsinki 1997-11-27)
- II. It is recommended that Member states require that a new type number be attached to a modified, earlier banned product, which has been brought into conformity. (Brussels 2000-04-26)
- III. Cord extension sets fall within the scope of the LVD. The CE-marking is best placed somewhere along the cord, e.g. directly on the cord in the form of a tag or suchlike. In the case of a multiple socket-outlet cord extension set the CE-marking may be affixed on the cord or on the multiple socket-outlet enclosure. (Brussels 2001-06-19)
- IV. When a sales ban or recall is decided the issuing Member State should ensure, if possible, that the manufacturer, his authorised representative or the EEA-importer, is informed at the earliest possible stage. (Brussels 2001-06-11)
Note: Now covered by Regulation on Accreditation & Market Surveillance², Regulation 765/2008.
- V. The safety warnings and safety instructions needed to ensure that electrical equipment will be used safely and for intended applications shall be marked on the equipment. If this is not possible the warnings and instructions shall be made available on an accompanying paper. Providing the safety warnings and safety instructions on an accompanying CD-ROM, DVD, or on other media requiring additional equipment to read them, does not fulfil the requirement in paragraph 1a of Annex I of the Low Voltage Directive.

This has been confirmed and approved during the LVD-ADCO meeting on:
16/17-11-2010.²

1. OJ L 374/10, 27.12.2006 2. OJ L 218/30, 13.8.2008
2. It will replace Recommendations of the Administrative Co-operation Working Group (LVD ADCO) - 1997-2006 [103 KB]

OSM/EE DECISION SHEET

Category	Standard:	Clause	Document no.
OFF	EN 60950-1: 2006 + A1 + A2 EN 62368-1:2014	General	OSM-EE 19/3
Subject		Key words	Meeting
Mains socket outlets with USB or other incorporated electronic components		Socket outlet, USB	Ljubljana 2019
Question			
<p>There are mains sockets outlets which include USB charger ports or other incorporated electronic components available on the market</p> <div style="display: flex; justify-content: space-around; align-items: center;">   </div> <p>Do the standards EN 60950-1: 2006 + A1 + A2 or EN 62368-1:2014 apply as end product standard to these types of devices?</p>			
Decision			
<p>No. The end product standard for a mains socket outlet for building installation, containing mains and electronic components, is IEC 60884-1 as adopted by national standard. Only the electronic part is within the scope of the EN 60950-1 or EN 62368-1</p>			
Explanatory notes			
<p>OVC III applies for such products</p> <p>The requirements for disconnecting devices from EN 60950-1 and EN 62368-1 do not apply</p> <p>Moreover, the requirements such as mechanical strength, surface temperature and flammability requirements for the USB part of a mains socket outlet need to comply with the relevant end-product standard</p> <p>British Standard BS 1363-2:2016 + A1: 2018 Annex I provides useful information on these types of devices</p>			



OSM/EE DECISION SHEET

Category	Standard:	Clause	Document no.
OFF	EN 60950-1: 2006 + A1 + A2 EN 62368-1:2014	General	OSM-EE 19/4
Subject		Key words	Meeting
Safety related control function depending on software for compliance with EN 60950-1 and EN 62368-1			Ljubljana 2019
Question			
<p>How do OSM/EE treat software control for compliance with EN 60950-1 and EN 62368-1?</p> <p>Example:</p> <p>An integrated circuit is used as a protection to avoid overcharging a lithium battery. The circuit has a register which can turn on a charge circuit, which is causing problems with accepting this part, because failures in the software are not specified. This is also possible while doing testing in single fault condition and at the same time having (in this particular case) the software-controlled charge circuit turned on</p>			
Decision			
<p>As the software evaluation is not part of EN 60950-1 and EN 62368-1, OSM-EE is of the opinion that software control cannot be considered as part of a safety protection system, unless it is in compliance with IEC/EN 61508 series</p>			
Explanatory notes			
<p>See the notes in the scope of EN 62368-1</p> <p>This decision replaces OSM/EE 05/3 and OSM/EE 09/05</p>			



OSM/EE DECISION SHEET

Category	Standard:	Clause	Document no.
ITAV	EN 62368-1:2014 + A11:2017 EN IEC 62368-1:2020 + A11:2020	5.4.4.9	OSM/EE 20/2
Subject	Key words	Meeting	Status
Upper working frequency for TIW	TIW at frequencies higher than 30 kHz	Online meeting 1 April 2020	Approved
Question			
<p>Solid insulation requirements at frequencies higher than 30 kHz. Increasing the frequency will reduce the electric strength of most insulating materials.</p> <p>How should we deal with certified TIW used in applications with frequencies higher than 30 kHz, in cases the upper working frequency is not specified in its safety approvals?</p> <p>Example from Furukawa for their TEX series of triple insulated winding wire. TUV RH and VDE specifies up to 500 kHz.</p>			
Decision			
For TIW certified to EN 62368-1 without a specification for the upper frequency, may be accepted provided that breakdown electric field strength in clause 5.4.4.9 has been considered			
Explanatory notes			



OSM/EE DECISION SHEET

Category	Standard:	Clause	Document no.
ITAV	EN 62368-1:2014 + A11:2017 EN IEC 62368-1:2020 + A11:2020	6.4.5 and 6.5	OSM/EE 20/3
Subject	Key words	Meeting	Status
UL 758 certified conductors	Conductors, VW-1	Online meeting 1 April 2020	Approved
Question			
The EN 62368-1 standard requires in cl 6.4.5 and 6.5 for conductors to meet EN 60332 standards or EN 60695-11-21. Is UL 758 (as per UL dev in the UL 62368-1) accepted as an alternative for this requirement?			
Decision			
Yes if the UL 758 certification covers the VW-1 test			
Explanatory notes			
EN 60368-1 2020: note of clause 6.5.1 refers to UL 2556 According to Annex DVF in UL/CSA 62368-1, UL 758 is an alternative to IEC 60332-1. So wiring and its insulation complying with UL 758 is OK for US/CAN certification. UL 2556 is a standard for test methods used to support UL 758			

OSM/EE DECISION SHEET

Category	Standard:	Clause	Document no.
ITAV	EN 62368-1:2014 + A11:2017 EN IEC 62368-1:2020 + A11:2020	M.4.2	OSM-EE 21/1
Subject	Key words	Meeting	
Charging safeguards for equipment powered by secondary lithium battery	Lithium battery, Charging safeguards	Online meeting 12-15 April 2021	
Question			
<p>The affected equipment (amplifier with radio) is powered by mains or internal lithium batteries which can be recharged in the equipment by a direct wall plug-in charger. Although intended for indoor / outdoor use, it is not classified as outdoor equipment.</p> <p>The M.4.1 requirement is as follows :</p> <p>“The battery charging circuit shall stop charging when the temperature of the battery exceeds the highest specified charging temperature. The battery charging circuit shall limit the current to the value specified by the battery manufacturer when the battery temperature is lower than the lowest specified charging temperature. »</p> <p>This is a requirement for normal operating conditions, abnormal operating conditions or single fault conditions.</p> <p>The limits provided by battery manufacturer are 0°C and 45°C.</p> <p>No temperature limits provided for end product in User Manual.</p> <p>There are two opposite interpretations:</p> <ol style="list-style-type: none"> 1) The equipment should be tested two times in a climatic chamber at temperatures set for two values slightly exceeding the limits given for the battery and verified that the control circuit operates, 2) The temperature of the battery is measured during the charging under all conditions (Annex B) and, if the temperature does not reach the limits, the test is N/A. <p>Question : Which interpretation is correct, 1 or 2 ?</p>			
Decision			
It is the opinion of the OSM-EE that for equipment that is likely to be used in an environment that is outside of the manufacturer's ambient temperature limits for example portable equipment that may be used in a vehicle or outdoors, there shall be abnormal testing related to the upper and lower limits of ambient temperature.			
Explanatory notes			



OSM/EE DECISION SHEET



Category	Standard:	Clause	Document no.
ITAV	EN 62368-1:2014 EN IEC 62368-1:2020 + A11:2020	Annex F	22/1
Subject	Key words		Meeting
Safety instructions and markings	LPS, PS2		Online meeting 05-06 April 2022
Question			
Unit is class III product with HB rated enclosure, supplied by external power adapter meeting LPS/PS2 requirement through standard DC jack connector. What are requirements for marking and instructions in order to prevent ordinary person replacing adapter with different one, that does not comply with LPS/PS2?			
Decision			
<p>A Class III equipment with an enclosure made of HB material and using a non-special connector like DC jack connector and supplied by external power adapter has to have a marking stating the following:</p> <p>"Use only power supplies listed in the user instructions".</p> <p>or</p> <p>"For applicable power supplies see user instructions".</p> <p>This statement shall also be in the user instructions.</p> <p>The user instructions must then have a listing of manufacturers and models of the relevant power supplies.</p> <p>Standard interfaces like USB and the like that are expected to be in compliance with clause 6.6 of EN/EN IEC 62368-1 are excluded from this decision.</p>			
Explanatory notes			
Some power supplies with DC jack connector may exceed LPS/PS2 limits and therefore requirements for protection against fire are not fulfilled with used method control fire spread. Replaces decision 01/8 for EN 60950-1:2001.			



OSM/EE DECISION SHEET

Category	Standard:	Clause	Document no.
ITAV	EN 62368-1:2014 EN IEC 62368-1:2020 + A11:2020	4.1.2 5.5.2 G.11	22/2 rev 1
Subject	Key words	Meeting	
Capacitor across the mains	X-capacitor, bridge rectifier	Online meeting 05-06 April 2022 Copenhagen 12-13 April 2023	
Question			
What are requirements for a capacitor within ES3 circuit connected to AC mains located after bridge rectifier?			
Decision			
Requirements of clause 5.5.2 do not apply for a capacitor which is connected after a rectifier in an ES3 circuit connected to AC mains of a switch mode power supply.			
Explanatory notes			
<p>It is considered that capacitor after bridge rectifier is not subjected to same transient levels as capacitor before bridge rectifier (directly L to N or L to L).</p> <p>Capacitors before bridge rectifier and connected L to N or L to L must comply with appropriate class of EN 60384-14 standard (see G.11).</p> <p>Replaces decision 91/8 rev. 2012 for EN 60950: 2000; EN 60950-1: 2001; EN 60950-1:2006+A1, +A11 +A12.</p> <p>IEC TC108 HBSDT San Francisco Nov 2022: Agreed, but changed the question as follows: What are requirements for a capacitor across within ES3 circuit connected to AC mains located after bridge rectifier?</p>			

OSM/EE DECISION SHEET

Category	Standard:	Clause	Document no.
ITAV	EN 62368-1:2014 + A11:2017 EN IEC 62368-1:2020 + A11:2020	G.4.3	22/3 rev 1
Subject		Key words	Meeting
4mm banana plug		Banana plug Connector Loudspeaker connector	Online meeting 05-06 April 2022 Copenhagen 12-13 April 2023
Question			
Can audio input/output connectors that can accommodate 4mm banana plugs be accepted for domestic products?			
Decision			
<p>Connectors in which a 4mm plug can be inserted are not acceptable for domestic products. This does not preclude the use of connectors into which a conductor of diameter 4mm or greater can be inserted and clamped.</p> <div style="display: flex; align-items: flex-start;"> <div style="flex: 1;">  </div> <div style="flex: 2; padding-left: 10px;"> <p>This type of connector is designed to accept flexible or solid conductors. The conductor is inserted into the hole in the post and clamped with the insulated nut. Even if the hole for the cable has a diameter of 4mm or greater and could possibly accept a 4mm banana plug, the connector is acceptable.</p> </div> </div> <div style="display: flex; align-items: flex-start; margin-top: 10px;"> <div style="flex: 1;">  </div> <div style="flex: 2; padding-left: 10px;"> <p>This type of connector is designed to accept a 4mm banana plugs and is not acceptable.</p> </div> </div>			

In addition, the following dual loudspeaker plugs supplied by the manufacturer are allowed:

Dual loudspeaker plugs supplied by the manufacturer. Case 1:



Speaker plugs



The Classic Integrated is supplied with a pair of dual speaker plugs. To ensure safe operation of this amplifier, the speaker cables must be terminated with the supplied speaker plugs, assembled in accordance with the instruction supplied with the plugs.

Never terminate the cables with separate 4mm/banana plugs.

The above is accepted provided that:

the dual loudspeaker plugs have been tested and it is confirmed that the plugs cannot be inserted into a mains outlet and

there is an instructional safeguard on the rear of the amplifier to indicate only use of the dual speaker plugs supplied by the manufacturer, and worded a instruction has been added to the Instructions for Use.

Dual loudspeaker plugs supplied by the manufacturer. Case 2:

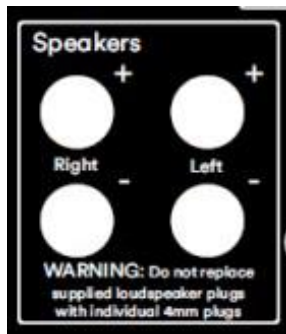

Another solution is also accepted provided that:

the dual loudspeaker plugs have been tested and it is confirmed that the plugs cannot be inserted into a mains outlet and

there is an instructional safeguard on the rear of the amplifier to indicate only use of the dual speaker plugs supplied by the manufacturer. No worded instruction has to be added to the Instructions for Use.

Explanatory notes

A 4mm banana plug can easily be inserted into a CEE 7 type mains socket outlet therefore its use in a domestic environment is not to be encouraged.



4mm banana plug

This decision updates decision OSM-EE 91/5 for EN 60065:1998; EN 60065:2002.

The proposal regarding the dual loudspeaker plugs supplied by the manufacturer was submitted by CLC TC108X and was agreed by the OSM-EE at the 2023 meeting in Copenhagen.

OSM/EE DECISION SHEET

Category	Standard:	Clause	Document no.
ITAV	EN 62368-1:2014 + A11:2017 EN IEC 62368-1:2020 + A11:2020	G.4.2	22/4 rev 1
Subject	Key words	Meeting	
Appliance Inlet for audio equipment	Appliance inlet, audio equipment	Online meeting 05-06 April 2022 Copenhagen 12-13 April 2023	
Question			
<p>For the connection to the mains of professional audio equipment is it allowed to use only connectors according to IEC 60320-1 or can alternative connectors be acceptable when means of stowage to protect the mains cord are provided? For example the following:</p> <div style="text-align: center;">  </div> <p>Certified according to EN 61984.</p>			
Decision			
Connectors certified according to EN 61984 are acceptable for professional and non-professional audio equipment.			
Explanatory notes			
<p>Decision history:</p> <p>OSM 2012: The OSM is of the opinion that this is acceptable. To be confirmed by IEC TC 108 MT1.</p> <p>OSM 2013: IEC TC108 MT1 Northbrook June 2012: Agreed. OSM agreed to update to a decision.</p> <p>OSM 2022: Replaces decision 13/3 for EN 60065:2002+A1+ A11+A2+A12. IEC TC108 HBSDT San Francisco Nov 2022: Agreed but requires a change also to accept the connectors certified according to EN 61984 for non-professional audio equipment.</p>			



OSM/EE DECISION SHEET

Category	Standard:	Clause	Document no.
ITAV	EN 62368-1:2014 EN IEC 62368-1:2020 +A11:2020	9.2	22/5
Subject	Key words	Meeting	
Touch Temperature of user replaceable PCB's e.g. Graphics Cards in personal computers	Accessible components within a personal computer	Online meeting 05-06 April 2022	
Question			
<p>Historically, the inside of a personal computer has been considered as accessible to 'ordinary' persons.</p> <p>Due to the historical statement above this leads to a question as to whether it is necessary to:</p> <ol style="list-style-type: none">1) Apply touch temperature limits to those parts of e.g. a Video Graphics Card or other type of accessory cards that may be accessible within an end product computer, when it can be interchanged with another similar accessory card by an ordinary person. <p>or</p> <ol style="list-style-type: none">2) Apply the touch temperature limits only to the accessible metal bracket that would be the only accessible part when the computer is assembled.			
Decision			
OSM-EE is of the opinion that option 2) is applicable.			
Explanatory notes			
It is the opinion of the OSM that this is in line with the risk of burn hazard as described in IEC Guide 117 clause 4.			

OSM/EE DECISION SHEET

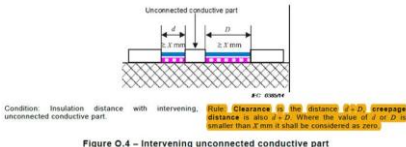
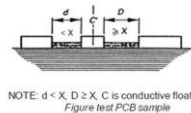
Category	Standard:	Clause	Document no.
ITAV	EN 62368-1:2014 + A11:2017 EN IEC 62368-1:2020 + A11:2020 EN IEC 60664-1:2020	ANNEX O	22/6 rev 1
Subject		Key words	Meeting
Measurement of creepage distances and clearances		Creepage, clearance	Online meeting 05-06 April 2022 Copenhagen 12-13 April 2023
Question			
<p>In IEC 62368-1:2014 ed.2.0 Annex O</p> <div style="text-align: center;">  </div> <p>In the figure above, there is an explanation indicates that: Rule: Clearance is the distance $d + D$, creepage distance is also $d + D$. Where the value of d or D is smaller than X mm it shall be considered as zero.</p> <p>In IEC 62368-1:2018 ed.3.0 Annex O, there is also same expression.</p> <p>Although, In IEC 60664-1: 2007 and IEC 60664-1:2020, there is no expression in this version of IEC 60664-1:2007 about the situation when d or $D < X$.</p> <p>But, DSH 2160 clarifies the dilemma as below and you can see the decision sheet screen shot:</p> <div style="text-align: center;">  </div> <p>Different interpretations of total creepage distance are as follows: Opinion 1: The creepage distance is measured as shown in IEC 60664-1:2007 example 11. Creepage distance is the distance = $d + D$. Opinion 2: Since the d is less than X, the d is considered as zero. Creepage distance is the distance = D. Which opinion is correct?</p> <p>Decision</p> <p>Opinion 1 is correct. Creepage distance is the distance = $d + D$.</p> <p>Question is, how shall we evaluate clearance and creepage distance according to IEC 62368-1 for unconnected conductive parts (floating conductors)? Should DSH 2160 decision sheet be considered or not?</p>			



Decision
DSH 2160 is to be considered.
Explanatory notes
Figure O.4 is changed in the draft ed 4 of 62368-1, 108/767/CDV and is in line with DSH 2160 for 60664-1. IEC TC108 HBSDT San Francisco Nov 2022: Agreed. Standards amended from IEC versions to EN EN/IEC versions



OSM/EE DECISION SHEET

Category	Standard:	Clause	Document no.
ITAV	EN IEC 62368-1:2020 + A11:2020	4.Z1	23/1
Subject	Key words		Meeting
Protective device within Pluggable Equipment Type A	Protective device within Pluggable Equipment Type A		Copenhagen 12-13 April 2023
Question			
<p>Request from CLC TC108X to make the interpretation TC108X/SEC0510/INF available for the public community by an OSM Decision.</p> <p>Ref CLC TC108X 30 Nov & 01 Dec 2022, agenda item 6.1 with the Decision 8:</p> <p>- EN IEC 62368-1:2020/A11:2020; Questionnaire and proposal on EN IEC 62368-1:2020/A11 Clause 4.Z1</p> <p>TC108X/SEC0507/Q; TC108X/SEC0507A/Q; TC108X/SEC0510/INF</p> <p>The Chair Mr. Kelleher asked the question if this interpretation now should be taken to OSM? TC108X took the following "Decision 8" on that question. The Secretariat will ask Mr. Andersen for a contact information from OSM.</p> <p>Decision 8 (Agenda item 6.1) TC 108X decided to ask OSM, if the interpretations can be made publicly available by OSM. Decision 8, Action 4, M. Andersen</p> <p>Q: Where a protective device is required in the equipment, what are its specific requirements relative to the operation of the building installation protective device?</p>			
Decision			
<p>Clarification on 4.Z1 based on TC108X/SEC0510/INF:</p> <p>Where a protective device is required within the equipment, the protective device within the equipment shall operate before or at the same time the expected building installation protection will operate.</p> <p>For earth faults in single-phase equipment, it is not necessary to provide 2 protective devices. It is expected that the building installation will protect against earth faults. This applies also in countries where an IT power distribution system is used.</p>			
Explanatory notes			
<p>See document: CLC/TC108X/SEC0510/INF 2022-04-26</p>			



CLC/TC108X/SEC0510/INF

2022-04-26

EUROPEAN COMMITTEE FOR ELECTROTECHNICAL STANDARDIZATION (CENELEC)

TECHNICAL COMMITTEE No. 108X: SAFETY OF ELECTRONIC EQUIPMENT WITHIN THE FIELDS OF AUDIO/VIDEO, INFORMATION TECHNOLOGY AND COMMUNICATION TECHNOLOGY

TC 108X Secretariat information on the results of SEC0507/Q on questionnaire and proposal on EN IEC 62368-1:2020/A11 Clause 4.Z1

Information

The TC 108X Secretariat has circulated the questionnaire TC 108X/SEC0507/Q on the questionnaire and proposal on EN IEC 62368-1:2020/A11 Clause 4.Z1 with the deadline 15th February 2022 for the latest reply.

The result of this questionnaire is as follows:

1) Participating TC108X members (NCs):

11 NCs have submitted their reply:

AT, BE, CZ, DE, FI, FR, Italy, IE, NOR, Slovenia, Sweden

2) Results of Questionnaire TC108X_SEC0507/Q:

Is the above interpretation accepted?

- YES (9x): AT, BE, DE, FI, FR, IE, Italy, NOR, Slovenia

- NO (1x): Sweden

- Abstain (1x): CZ

3) Remarks

Sweden noted, that:

- This is not an interpretation. It's a rewrite/clarification that was written to be included in a future amendment/edition of the standard.
- The impact on the industry has not been considered. If published as an interpretation it will have immediate effect and not allow manufacturers the grace period (usually 3 years) that would have been the case with a new amendment/edition.

The remarks of Sweden are noted.



OSM/EE DECISION SHEET

Category	Standard:	Clause	Document no.
ITAV	EN IEC 62368-1:2020 + A11:2020	5.7.6	23/4
Subject	Key words		Meeting
Safeguard against touch current exceeding ES2 limits	Touch current		Copenhagen 12-13 April 2023
Question			
<p>Are safeguards specified in clause 5.7.6 applicable also for cases when touch current exceeds ES2 limits when measured under applicable faults in equipment or supply faults in accordance with clause 6.2.2.3-6.2.2.9 of IEC 60990:2016 (Fault No. 2 to Fault No. 8)?</p> <p>Clause 5.7.6 only specifies safeguard for touch current exceeding ES2 limits for Fault No. 1 (reference to clause 6.2.2.2 of IEC 60990:2016).</p> <p>For example, if touch current for IT system (Fault No. 3) exceeds ES2 limits, can we consider clause 5.7.6 as applicable?</p>			
Decision			
Yes. Safeguards specified in clause 5.7.6 are also applicable for Faults 6.2.2.3 - 6.2.2.9 of IEC 60990:2016.			
Explanatory notes			
<p>Touch current of earthed accessible parts shall be measured according to clause 5.7.5 considering different faults in equipment or supply faults in accordance with clause 6.2.2 of IEC 60990:2016.</p> <p>Touch current may exceed ES2 limits only for products with a reliable connection to earth as specified in clause 5.7.6.</p> <p>OSM decision 18/5 clarifies that applicable Faults No. 2-8 (excluding Fault No. 7) shall be performed in combination with Fault No. 1. Therefore Clause 5.7.6 is applicable also for Faults No.2-8.</p>			



OSM/EE DECISION SHEET

Category	Standard:	Clause	Document no.
ITAV	EN 62368-1:2014 + A11:2017 EN IEC 62368-1:2020 + A11:2020	Annex M	23/5
Subject	Key words	Meeting	
Lead acid batteries	Lead acid batteries	Copenhagen 12-13 April 2023	
Question			
<p>A manufacturer has a DC stand-by system incorporating Lead Acid Energys Cyclon cells, which have been manufactured into a pack of 10 cells.</p> <p>Neither the batteries nor the pack have any formal approval.</p> <p>Clause M1 states that the batteries must comply with Annex M but equivalent tests that are part of the battery safety standard need not be repeated.</p> <p>However, M.2.1 states that batteries and their cells SHALL comply with relevant standards contained in a list, some of which are relevant to lead acid batteries.</p> <p>Question:</p> <p>Can the Standby system be approved to 62368-1 if the Lead Acid battery pack has been tested to Annex M without having the batteries fully tested to a relevant standard from the list in M.2.1?</p>			
Decision			
<p>Proposals for a decision:</p> <ol style="list-style-type: none">1) Yes, compliance with Annex M is sufficient2) No. compliance with both Annex M and any relevant standard listed in M.2.1 is needed3) Annex M in conjunction with the 3rd dash paragraph of clause 4.1.2 (testing of the battery according to the relevant battery standard under the conditions occurring in the equipment) <p>OSM-EE is of the opinion that option 3 is correct</p>			
Explanatory notes			